



## MIC911

### 105MHz Low-Power SOT23-5 Op Amp

#### General Description

The MIC911 is a high-speed operational amplifier which is unity gain stable regardless of resistive and capacitive load. It provides a gain-bandwidth product of 105MHz, a very low 1.25mA supply current, and features the Ittybitty® SOT23-5 package.

Supply voltage range is from  $\pm 2.5V$  to  $\pm 9V$ , allowing the MIC911 to be used in low-voltage circuits or applications requiring large dynamic range.

The MIC911 is stable driving any capacitive load and achieves excellent PSRR and CMRR, making it much easier to use than most conventional high-speed devices. Low supply voltage, low power consumption, and small packing make the MIC911 ideal for portable equipment. The ability to drive capacitive loads also makes it possible to drive long coaxial cables.

Data sheets and support documentation can be found on Micrel's web site at: [www.micrel.com](http://www.micrel.com).

#### Features

- 05MHz gain bandwidth product
- 1.25mA supply current
- Unconditionally unity gain stable
- Drives any capacitive load
- SOT23-5 package
- 120V/ $\mu s$  slew rate
- 112dB CMRR

#### Applications

- Video
- Imaging
- Ultrasound
- Portable equipment
- Line drivers
- XDSL

#### Ordering Information

Part Number	Temperature Range	Package	Lead Finish
MIC911BM5	-40° to +85°C	5-Pin SOT23	Standard
MIC911YM5	-40° to +85°C	5-Pin SOT23	Pb-Free

IttyBitty is a registered trademark of Micrel, Inc.

Micrel Inc. • 2180 Fortune Drive • San Jose, CA 95131 • USA • tel +1 (408) 944-0800 • fax + 1 (408) 474-1000 • <http://www.micrel.com>

### Pin Configuration

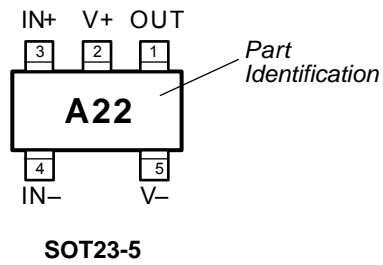

### Functional Pinout

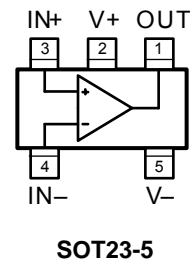

### Pin Description

Pin Number	Pin Name	Pin Function
1	OUT	Output: Amplifier Output
2	V+	Positive Supply (Input)
3	IN+	Non-inverting Input
4	IN-	Inverting Input
5	V-	Negative Supply (Input)

### Absolute Maximum Ratings<sup>(1)</sup>

Supply Voltage ( $V_{V+} - V_{V-}$ ).....	20V
Differential Input Voltage ( $ V_{IN+} - V_{IN-} $ ) <sup>(3)</sup> .....	4V
Input Common-Mode Range ( $V_{IN+} - V_{IN-}$ ).....	$V_{V+}$ to $V_{V-}$
Lead Temperature (soldering, 5 sec.).....	260°C
Storage Temperature ( $T_s$ ).....	150°C
ESD Rating <sup>(4)</sup> .....	1.5kV

### Operating Ratings<sup>(2)</sup>

Supply Voltage ( $V_s$ ).....	$\pm 2.5V$ to $\pm 9V$
Junction Temperature ( $T_j$ ).....	$-40^\circ C$ to $+85^\circ C$
Thermal Resistance.....	260°C/W

### Electrical Characteristics ( $\pm 5V$ )

$V_{V+} = +5V$ ,  $V_{V-} = -5V$ ,  $V_{CM} = 0V$ ,  $V_{OUT} = 0V$ ;  $R_L = 10M\Omega$ ;  $T_j = 25^\circ C$ , **bold** values indicate  $-40^\circ C \leq T_j \leq +85^\circ C$ ; unless noted.

Symbol	Parameter	Condition	Min	Typ	Max	Units
$V_{OS}$	Input Offset Voltage			1	<b>10</b>	mV
	Input Offset Voltage Temperature Coefficient			4		$\mu V/^\circ C$
$I_B$	Input Bias Current			1.5	4	$\mu A$
					<b>8</b>	$\mu A$
$I_{OS}$	Input Offset Current			0.03	2	$\mu A$
					<b>3</b>	$\mu A$
$V_{CM}$	Input Common-Mode Range	CMRR > 60dB	<b>-3.5</b>		<b>+3.5</b>	V
CMRR	Common-Mode Rejection Ratio	$-3V < V_{CM} < +3V$	<b>80</b>	110		dB
PSRR	Power Supply Rejection Ratio	$\pm 5V < V_s < \pm 9V$	<b>75</b>	88		dB
$A_{VOL}$	Large-Signal Voltage Gain	$R_L = 2k, V_{OUT} = \pm 2V$	<b>65</b>	78		dB
		$R_L = 200\Omega, V_{OUT} = \pm 1V$	<b>65</b>	78		dB
$V_{OUT}$	Maximum Output Voltage Swing	positive, $R_L = 2k\Omega$	+3.3 <b>+3.0</b>	3.5		V V
		negative, $R_L = 2k\Omega$		-3.5	-3.3	V V
					<b>-3.0</b>	V
		positive, $R_L = 200\Omega$	+2.8 <b>+2.5</b>	3.2		V V
		negative, $R_L = 200\Omega$ , <b>Note 5</b>		-2.5	-1.7	V V
	negative, $R_L = 200\Omega$ , $25^\circ C \leq T_j \leq +85^\circ C$ , <b>Note 5</b>				<b>-1.0</b> <b>-1.7</b>	V V
GBW	Unity Gain-Bandwidth Product	$R_L = 1k\Omega$		95		MHz
BW	-3dB Bandwidth	$A_V = 2, R_L = 470\Omega$		70		MHz
SR	Slew Rate			100		V/ $\mu s$
$I_{GND}$	Short-Circuit Output Current	source		65		mA
		sink		17		mA
	Supply Current			1.25	1.8	<b>2.3</b>

## Electrical Characteristics

$V_{V+} = +9V$ ,  $V_{V-} = -9V$ ,  $V_{CM} = 0V$ ,  $V_{OUT} = 0V$ ;  $R_L = 10M\Omega$ ;  $T_J = 25^\circ C$ , **bold** values indicate  $-40^\circ C \leq T_J \leq +85^\circ C$ ; unless noted.

Symbol	Parameter	Condition	Min	Typ	Max	Units
$V_{OS}$	Input Offset Voltage			1	<b>10</b>	mV
	Input Offset Voltage Temperature Coefficient			4		$\mu V/^\circ C$
$I_B$	Input Bias Current			1.5	4	$\mu A$
					<b>8</b>	$\mu A$
$I_{OS}$	Input Offset Current			0.03	2	$\mu A$
					<b>3</b>	$\mu A$
$V_{CM}$	Input Common-Mode Range	CMRR > 60dB	<b>-7.5</b>		<b>+7.5</b>	V
CMRR	Common-Mode Rejection Ratio	$-7V < V_{CM} < 7V$	<b>80</b>	112		dB
$A_{VOL}$	Large-Signal Voltage Gain	$R_L = 2k\Omega$ , $V_{OUT} = \pm 6V$	<b>65</b>	80		dB
$V_{OUT}$	Maximum Output Voltage Swing	positive, $R_L = 2k\Omega$	+7.2	+7.4		V
			<b>+6.8</b>			V
		negative, $R_L = 2k\Omega$		-7.4	-7.2	V
					<b>-6.8</b>	V
GBW	Unity Gain-Bandwidth Product	$R_L = 1k\Omega$		105		MHz
BW	-3dB Bandwidth	$A_V = 2$ , $R_L = 470\Omega$		80		MHz
SR	Slew Rate			120		V/ $\mu s$
$I_{GND}$	Short-Circuit Output Current	source		80		mA
		sink		22		mA
	Supply Current			1.35	1.9	mA
					<b>2.4</b>	mA

### Notes:

- Exceeding the absolute maximum rating may damage the device.
- The device is not guaranteed to function outside its operating rating.
- Exceeding the maximum differential input voltage will damage the input stage and degrade performance (in particular, input bias current is likely to change).
- Devices are ESD sensitive. Handling precautions recommended. Human body model, 1.5k in series with 100pF.
- Output swing limited by the maximum output sink capability, refer to the short-circuit current vs. temperature graph in "Typical Characteristics."

Test Circuits

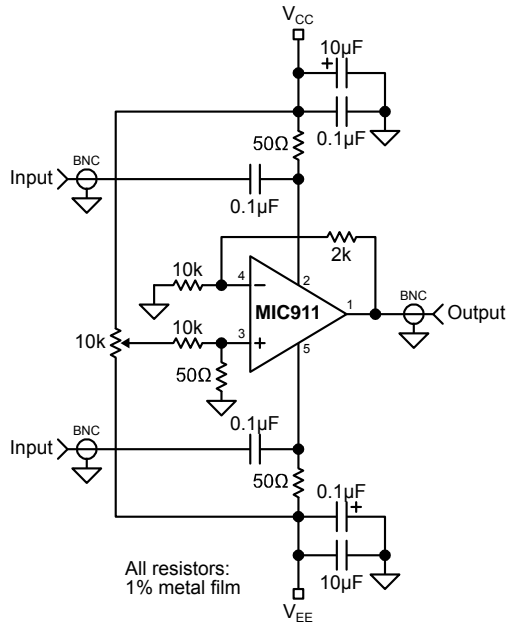

PSRR vs. Frequency

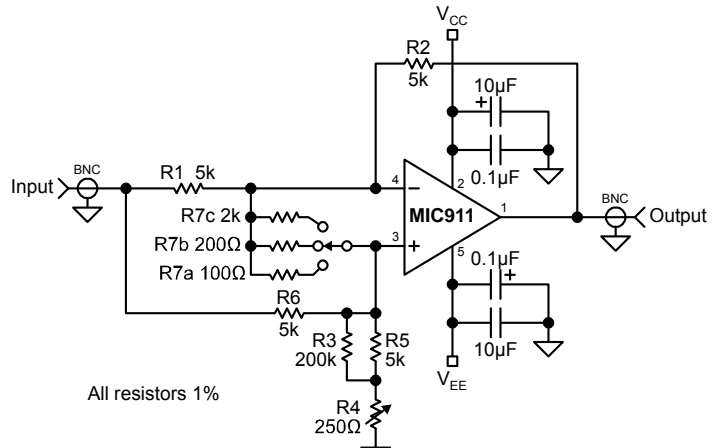

$$V_{OUT} = V_{ERROR} \left( 1 + \frac{R2}{R1} + \frac{R2 + R5 + R4}{R7} \right)$$

CMRR vs. Frequency

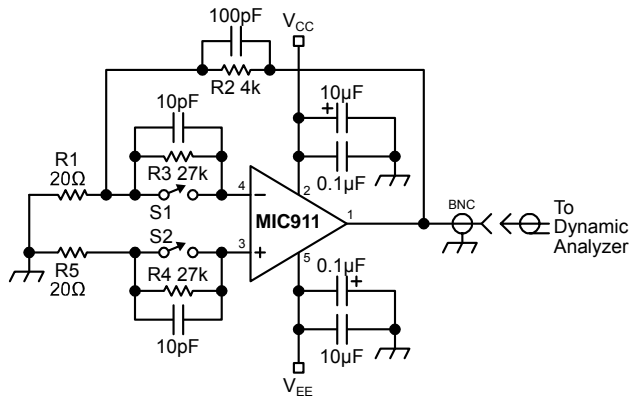

Noise Measurement

# Typical Characteristics

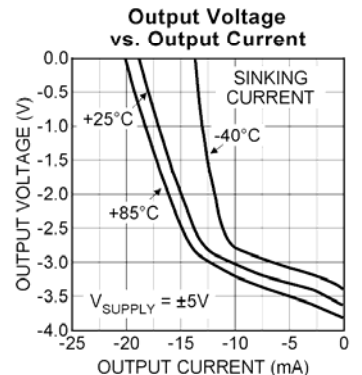
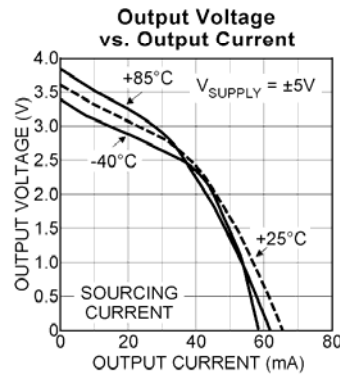
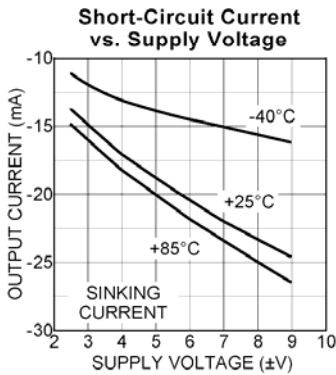
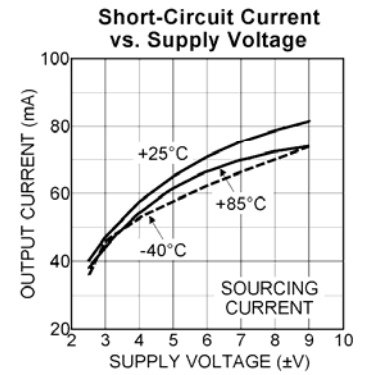
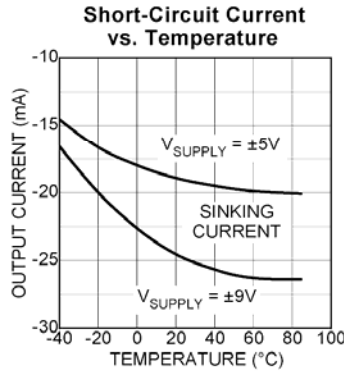
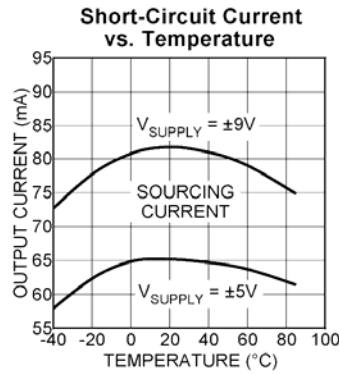
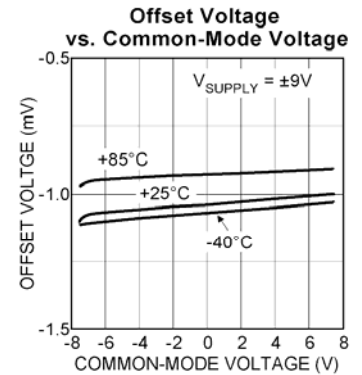
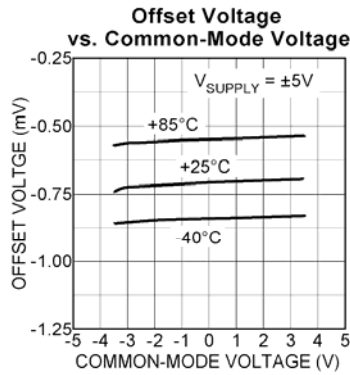
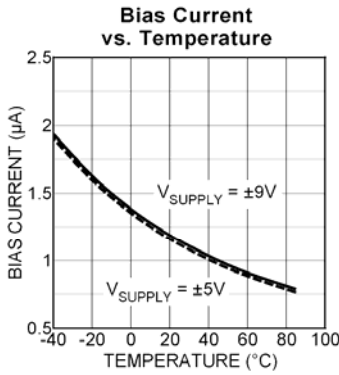
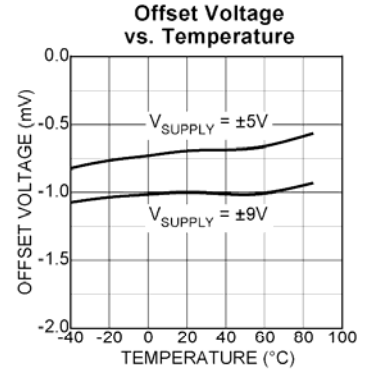
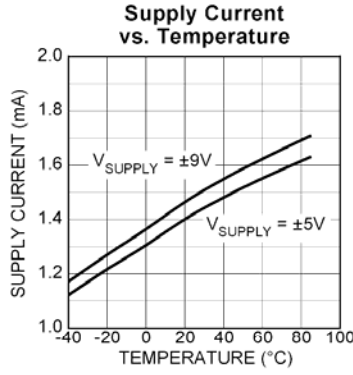
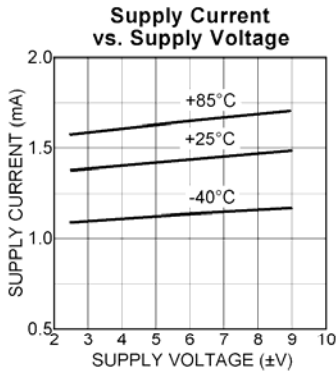

Typical Characteristics (continued)

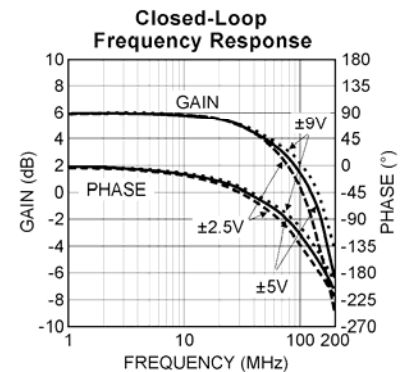
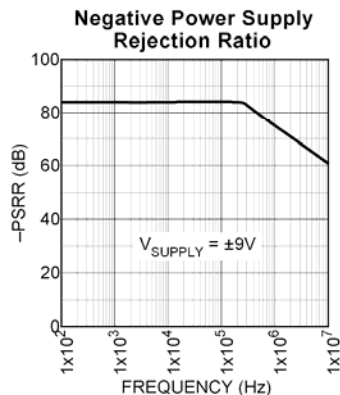
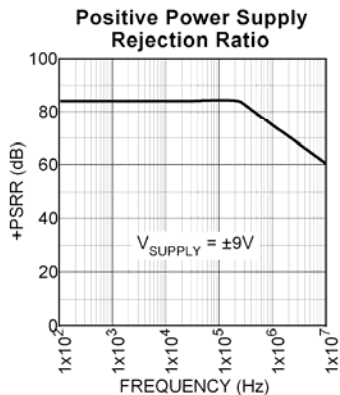
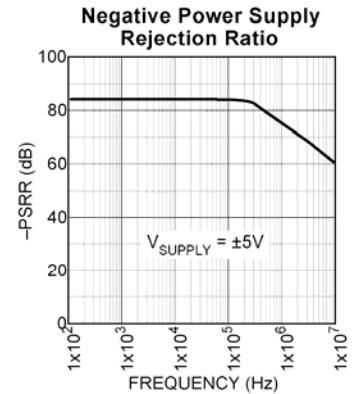
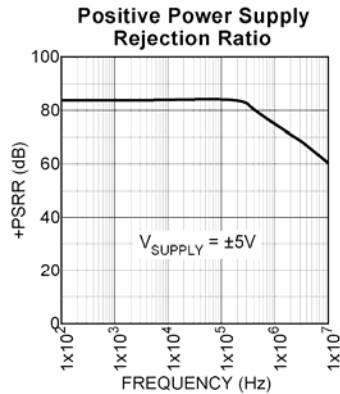
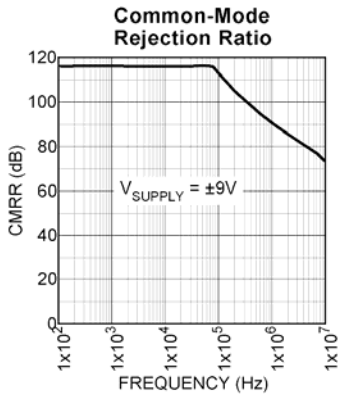
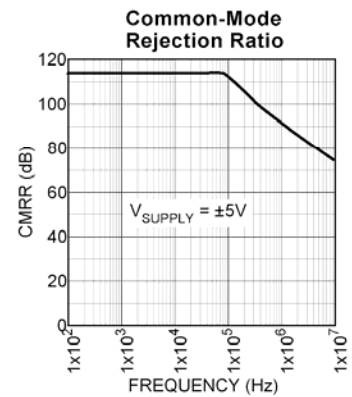
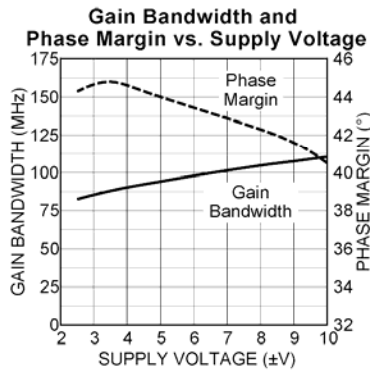
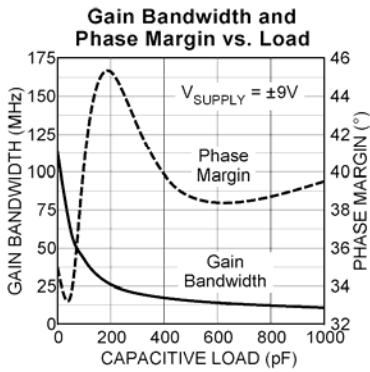
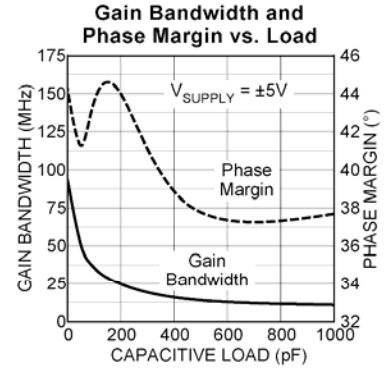
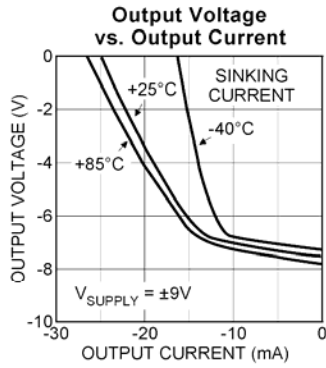
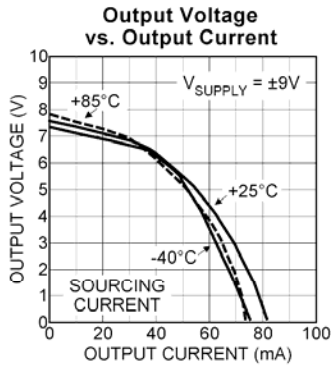

## Typical Characteristics (continued)

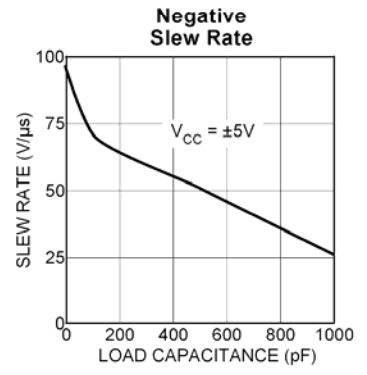
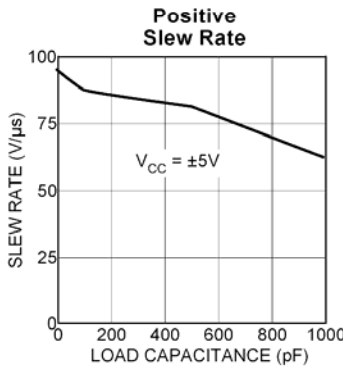
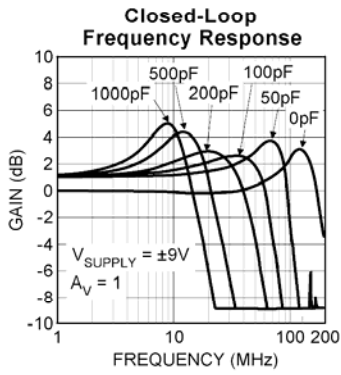
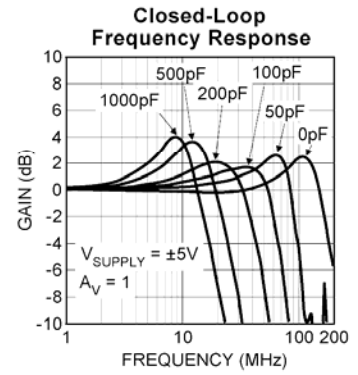
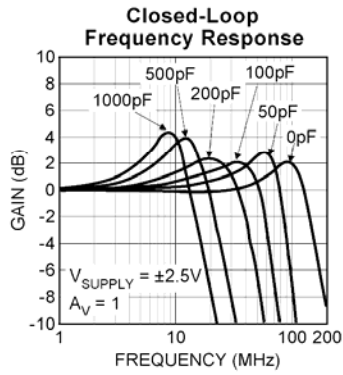
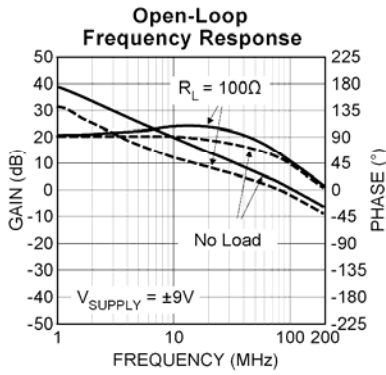
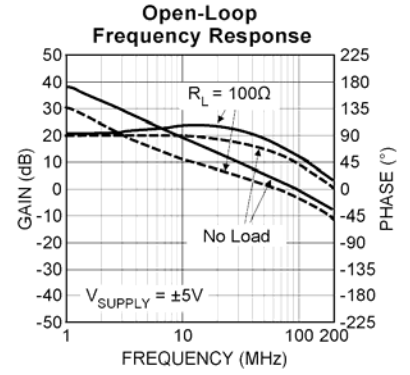
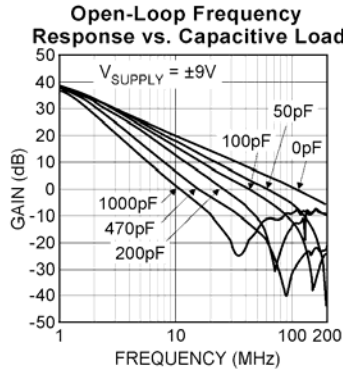
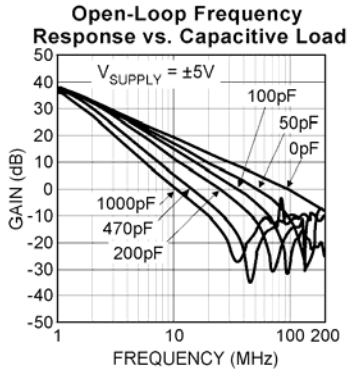

**Closed-Loop Frequency Response Test Circuit**

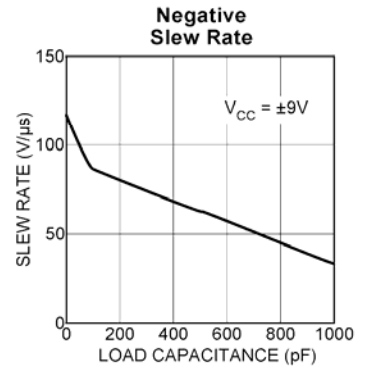
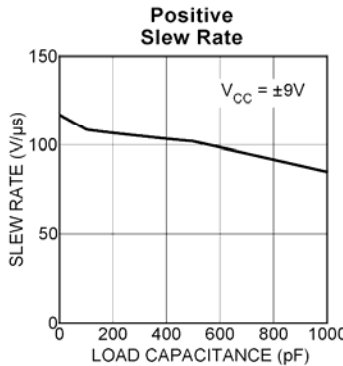
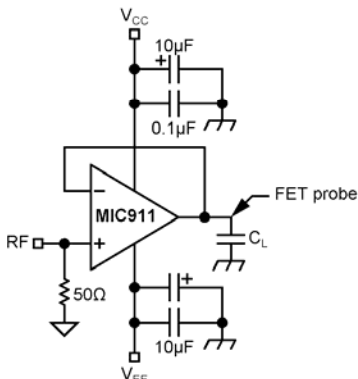



### Typical Characteristics (continued)

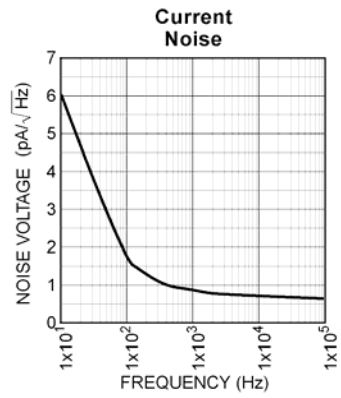
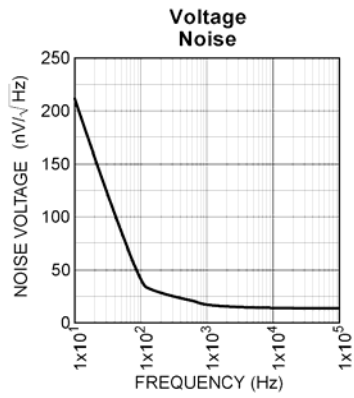

## Functional Characteristics

**Small-Signal  
Pulse Response**

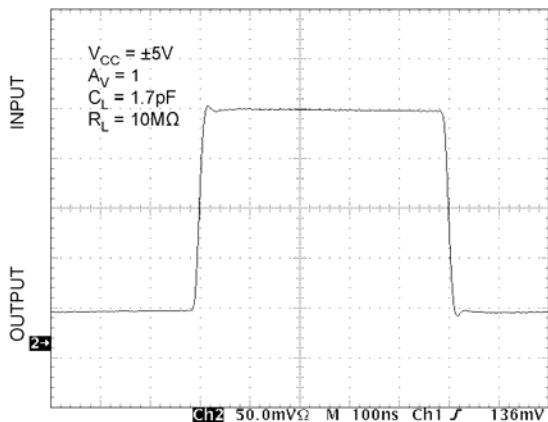

**Small-Signal  
Pulse Response**

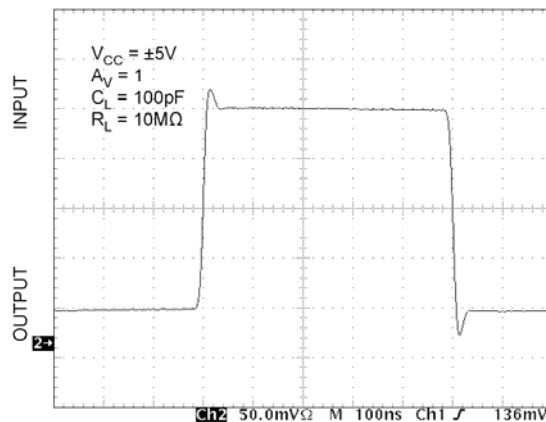

**Small-Signal  
Pulse Response**

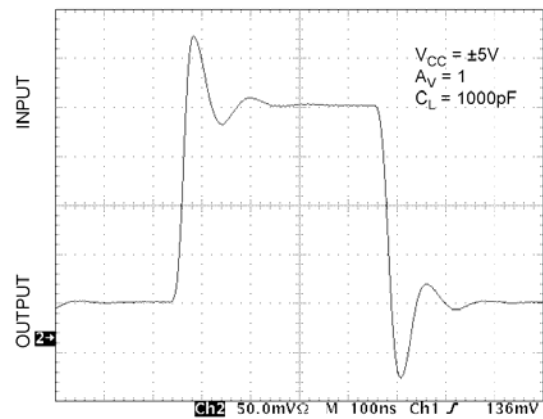

**Small-Signal  
Pulse Response**

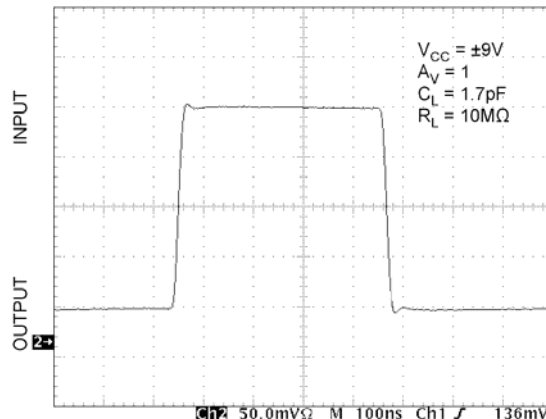

**Small-Signal  
Pulse Response**

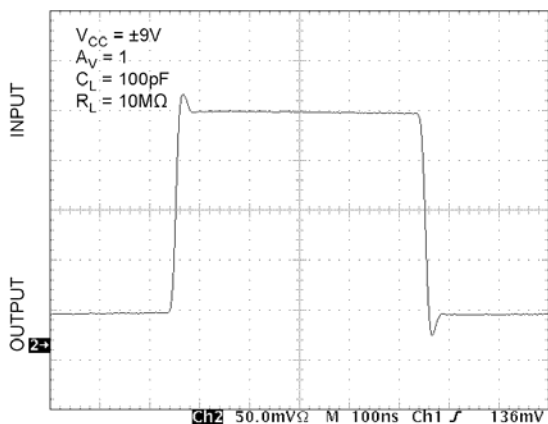

**Small-Signal  
Pulse Response**

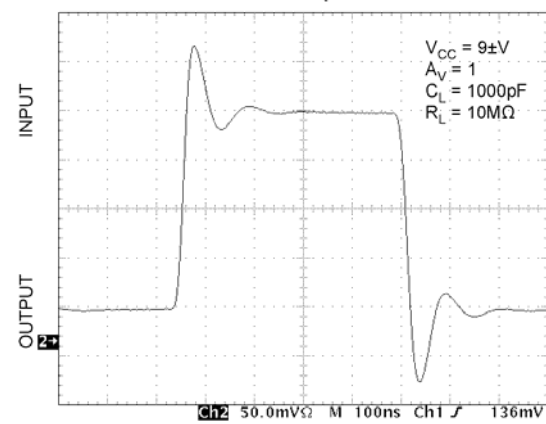

Functional Characteristics (continued)

Large-Signal Pulse Response

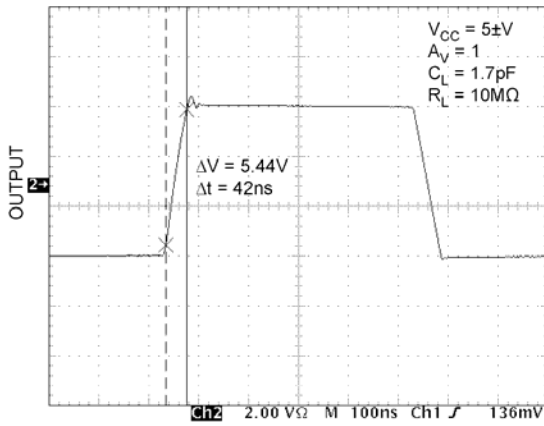

Large-Signal Pulse Response

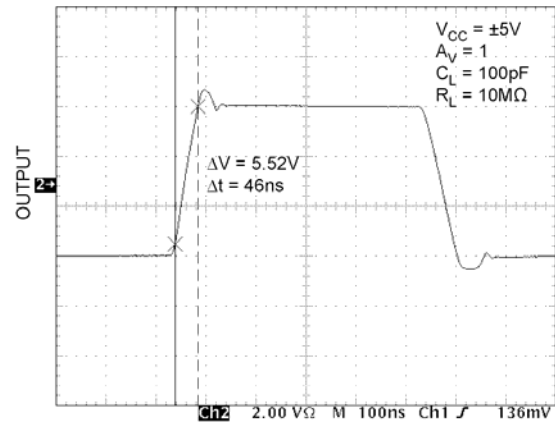

Large-Signal Pulse Response

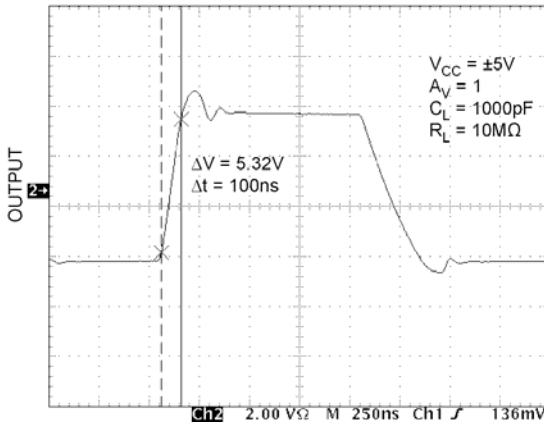

Large-Signal Pulse Response

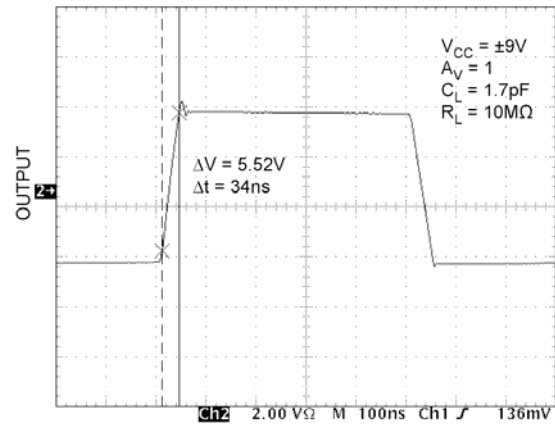

Large-Signal Pulse Response

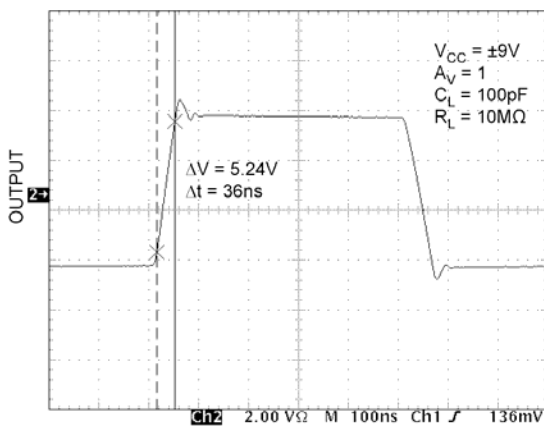

Large-Signal Pulse Response

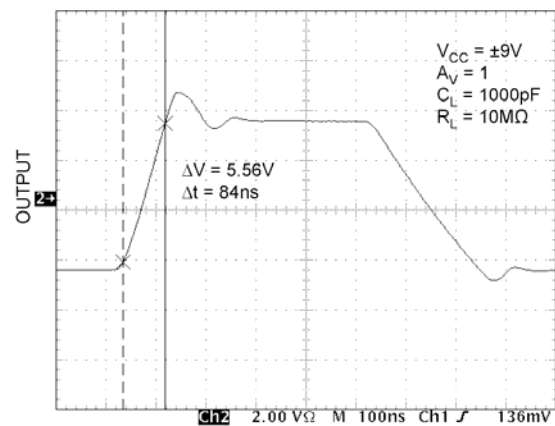

## Application Information

The MIC911 is a high-speed, voltage-feedback operational amplifier featuring very low supply current and excellent stability. This device is unity gain stable and capable of driving high capacitance loads.

### Driving High Capacitance

The MIC911 is stable when driving any capacitance (see “Typical Characteristics: Gain Bandwidth and Phase Margin vs. Load Capacitance”) making it ideal for driving long coaxial cables or other high-capacitance loads.

Phase margin remains constant as load capacitance is increased. Most high-speed op amps are only able to drive limited capacitance.

Note: increasing load capacitance does reduce the speed of the device (see “Typical Characteristics: Gain Bandwidth and Phase Margin vs. Load”). In applications where the load capacitance reduces the speed of the op amp to an unacceptable level, the effect of the load capacitance can be reduced by adding a small resistor (<100Ω) in series with the output.

### Feedback Resistor Selection

Conventional op amp gain configurations and resistor selection apply; the MIC911 is NOT a current feedback device. Resistor values in the range of 1k to 10k are recommended.

### Layout Considerations

All high speed devices require careful PCB layout. The high stability and high PSRR of the MIC911 make this op amp easier to use than most, but the following guidelines should be observed: Capacitance, particularly on the two inputs pins will degrade performance; avoid large copper traces to the inputs. Keep the output signal away from the inputs and use a ground plane.

It is important to ensure adequate supply bypassing capacitors are located close to the device.

### Power Supply Bypassing

Regular supply bypassing techniques are recommended. A 10μF capacitor in parallel with a 0.1μF capacitor on both the positive and negative supplies is ideal. For best performance all bypassing capacitors should be located as close to the op amp as possible and all capacitors should be low ESL (equivalent series inductance), ESR (equivalent series resistance). Surface-mount ceramic capacitors are ideal.

### Thermal Considerations

The SOT23-5 package, like all small packages, has a high thermal resistance. It is important to ensure the IC does not exceed the maximum operating junction (die) temperature of 85°C. The part can be operated up to the absolute maximum temperature rating of 125°C, but between 85°C and 125°C performance will degrade, in particular CMRR will reduce.

A MIC911 with no load, dissipates power equal to the quiescent supply current \* supply voltage.

$$P_{D(\text{no load})} = (V_{V+} - V_{V-})I_S$$

When a load is added, the additional power is dissipated in the output stage of the op amp. The power dissipated in the device is a function of supply voltage, output voltage and output current.

$$P_{D(\text{output stage})} = (V_{V+} - V_{V-})I_{OUT}$$

$$\text{Total Power Dissipation} = P_{D(\text{no load})} + P_{D(\text{output stage})}$$

Ensure the total power dissipated in the device is no greater than the thermal capacity of the package. The SOT23-5 package has a thermal resistance of 260°C/W.

$$\text{Max. Allowable Power Dissipation} = \frac{T_{J(\text{max})} - T_{A(\text{max})}}{260W}$$

**Package Information**

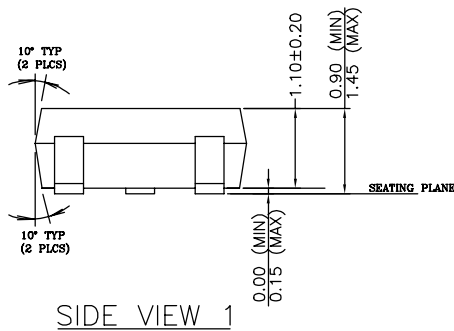
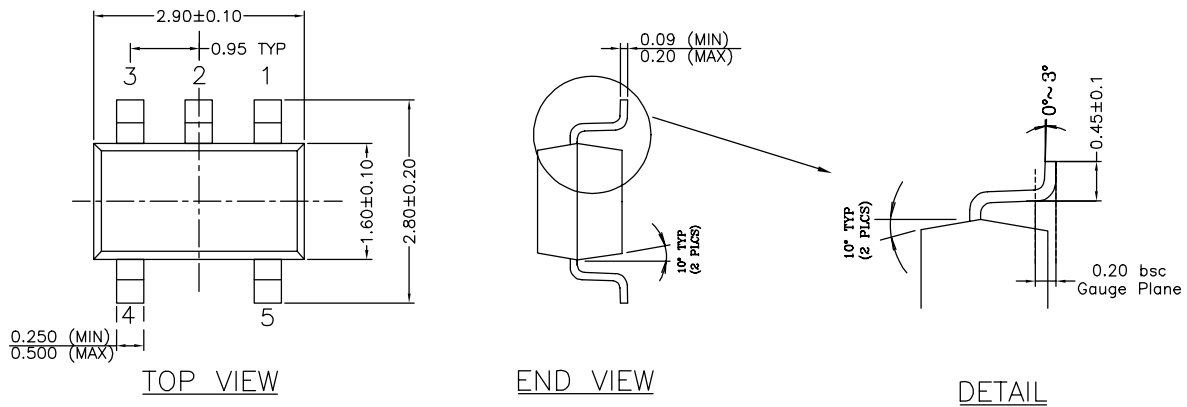

- NOTE:
1. PACKAGE OUTLINE EXCLUSIVE OF MOLD FLASH & BURR.
  2. PACKAGE OUTLINE INCLUSIVE OF SOLER PLATING.
  3. DIMENSION AND TOLERANCE PER ANSI Y14.5M, 1982.
  4. FOOT LENGTH MEASUREMENT BASED ON GAUGE PLANE METHOD.
  5. DIE FACES UP FOR MOLD, AND FACES DOWN FOR TRIM/FORM.
  6. ALL DIMENSIONS ARE IN MILLIMETERS.

**5-Pin SOT23 (M5)**

**MICREL, INC. 2180 FORTUNE DRIVE SAN JOSE, CA 95131 USA**  
 TEL +1 (408) 944-0800 FAX +1 (408) 474-1000 WEB <http://www.micrel.com>

The information furnished by Micrel in this data sheet is believed to be accurate and reliable. However, no responsibility is assumed by Micrel for its use. Micrel reserves the right to change circuitry and specifications at any time without notification to the customer.

Micrel Products are not designed or authorized for use as components in life support appliances, devices or systems where malfunction of a product can reasonably be expected to result in personal injury. Life support devices or systems are devices or systems that (a) are intended for surgical implant into the body or (b) support or sustain life, and whose failure to perform can be reasonably expected to result in a significant injury to the user. A Purchaser's use or sale of Micrel Products for use in life support appliances, devices or systems is a Purchaser's own risk and Purchaser agrees to fully indemnify Micrel for any damages resulting from such use or sale.

© 2000 Micrel, Incorporated.